

Torpedo Live User's Manual V2

Professional digital loadbox



The complete electronic version of this manual, as well as the Two notes Audio Engineering software and hardware products, are subject to updates. You can download the most recent versions of the products on the [Two notes Audio Engineering](http://www.two-notes.com) website.

This manual describes the Torpedo Live and provides instructions for its operation. It is highly recommended that you read this document before using the product. The contents of this manual have been thoroughly verified and it is believed, unless stated otherwise, to accurately describe the product at the time of shipment from the factory or download from our website.

Two notes Audio Engineering is a registered trademark of:

OROSYS SAS

76 rue de la Mine
34980 Saint-Gély-du-Fesc
France
Tel: +33 (0)484 250 910
Fax: +33 (0)467 595 703
Contact and support: <http://support.two-notes.com>
Website: <http://www.two-notes.com>

This document is the exclusive property of OROSYS SAS. In the interest of product development, OROSYS SAS reserves the right to change technical specifications, modify and/or cease production without prior notice. OROSYS SAS cannot be held responsible for any damage, accidental or otherwise, that results from an inappropriate use of the Torpedo Live. Please refer to the safety instructions included in this manual. The reproduction of any part of this document is strictly forbidden without the written authorization of OROSYS SAS.

All product names and trademarks are the property of their respective owners. Product names and trademarks found in this document were used during the development of the Torpedo Live product but are in no way associated or affiliated with OROSYS SAS.

1. Foreword

1.1 Safety instructions

Before using the product, it is necessary to carefully read and to bear in mind the following information. **Keep this document in a safe place as it is important for the protection of both user and product.** Should you suspect any malfunction of the device, always seek the assistance of a qualified technician.

1.1.1 Risk of electric shock



The triangle with a lightning bolt means that some parts of the product, even when the power is turned off or unplugged, can retain voltage high enough to cause serious electric shock. Any operation that requires opening the device should be left to a qualified technician.

1.1.2 Reader warning



The triangle with an exclamation mark highlights important messages concerning the correct use of the device.

1.1.3 Mains power

Please verify that the voltage required by the unit matches the voltage of your country. If not or if unsure, don't connect the unit to the wall outlet, this could result in damages to the unit and injuries to the user. This product must not be used when there is lightning. In case of severe weather with a risk of lightning, unplug the mains power supply to reduce the risk of electric shock and fire. The mains power cable provided with the unit complies with the standards of the country where you purchased the product. If replacement is needed, please use a standard compliant cable.

1.1.4 Ground connection

For safety reasons, the unit needs to be plugged to a wall outlet providing a ground connection. If your electric installation does not provide a ground connection or if you are unsure, please ask a qualified electrician for help.

If your mains power cable doesn't match your wall outlet, ask a qualified electrician for help. Never remove the outer or inner ground connection of the unit to prevent risks of electric shock or fire.

1.1.5 Safety use conditions

The Torpedo Live must never be used near a heat source, near a flame, in the rain, in damp areas, near any kinds of liquids. The unit is designed to be rackmounted into a 19" rack unit with 4 screws (not provided). When transporting the unit, care needs to be taken to avoid any shocks that could cause damage that would require the assistance of a qualified technician. Never cover or restrict the ventilation openings. Never unplug or deactivate the heat control monitoring system, or you will be exposed to risk of electric shock and fire.

1.1.6 Cleaning

Always use a dry and soft cloth with no alcohol or solvents for cleaning. Please keep the unit clean and free from dust.

1.1.7 Maintenance

All maintenance operations must be done by service centers approved by OROSYS SAS or by qualified technicians. Never try to repair the unit by yourself.

1.2 Contents of the package

The shipped package contains:

- One Torpedo Live unit in a protecting sleeve
- One mains power cable

- One USB cable
- One owner's manual

The complete electronic version of this manual, as well as the Torpedo Remote and Torpedo BlendIR softwares are subject to updates. You can download the most recent versions of these products on the [Two notes Audio Engineering](http://wiki.two-notes.com) website.

1.3 Declaration of conformity

Manufacturer: OROSYS SAS

Category of product: digital audio signal processor

Product: Torpedo Live

Test Manager: Guillaume Pille

The Two notes Torpedo Live is certified to be compliant to the CE and FCC standards:

- EN 55103-1 : 1996 and EN 55103-2 : 1996.
- EN 60065 05/2002 + A1 05/2006.
- EMC directive 89/336/EEC and Low Voltage Directive 73/23/EEC.
- FCC Part 15 : 2008.
- ICES-003 : 2004.
- AS/NZS 3548 class B for Australia and New Zealand.
- IEC : 2008 - CISPR 22 class B.



1.4 Disposal of Waste Equipment by Users in Private Household in the European Union



This symbol on the product or on its packaging indicates that this product must not be disposed of with your other household waste. Instead, it is your responsibility to dispose of your waste equipment by handing it over to a designated collection point for the recycling of waste electrical and electronic equipment. The separate collection and recycling of your waste equipment at the time of disposal will help to conserve natural resources and ensure that it is recycled in a manner that protects human health and the environment. For more information about where you can drop off your waste equipment for recycling, please contact your local city office, your household waste disposal service or the shop where you purchased the product.

1.5 Warranty

OROSYS SAS warrants that this TWO NOTES AUDIO ENGINEERING product shall be free of defects in

parts and workmanship when used under normal operating conditions for a period of two (2) years from the date of purchase. This warranty shall apply to the original purchaser when purchased from an Authorized TWO NOTES AUDIO ENGINEERING dealer.

IMPORTANT: PLEASE RETAIN YOUR SALES RECEIPT, AS IT IS YOUR PROOF OF PURCHASE COVERING YOUR LIMITED WARRANTY. THIS LIMITED WARRANTY IS VOID WITHOUT YOUR SALES RECEIPT.

Defective products that qualify for coverage under this warranty will be repaired or replaced, (at OROSYS SAS's sole discretion) with a like or comparable product, without charge. In the case that warranty service is required, Please contact your authorized TWO NOTES AUDIO ENGINEERING dealer in order to obtain an RMA to return the complete product to the Authorized TWO NOTES AUDIO ENGINEERING Service Center closest to you, with proof of purchase, during the applicable warranty period.

Transportation costs to the service center ARE NOT INCLUDED in this limited warranty. OROSYS SAS will cover the cost of standard ground return transportation for repairs performed under this warranty. This limited warranty becomes void if the serial number on the product is defaced or removed, or the product has been damaged by alteration, misuse including connection to faulty or unsuitable ancillary equipment, accident including lightning, water, fire, or neglect; or if repair has been attempted by persons not authorized by OROSYS SAS. Any implied warranties, including without limitation, any implied warranties of merchantability or fitness for any particular purpose, imposed under state or provincial law are limited to the duration of this limited warranty. Some states or provinces do not allow limitations on how long an implied warranty lasts, so the above limitations may not be applicable.

OROSYS SAS ASSUMES NO LIABILITY FOR PROPERTY DAMAGE RESULTING FROM ANY FAILURE OF THIS PRODUCT NOR ANY LOSS OF INCOME, SATISFACTION, OR DAMAGES ARISING FROM THE LOSS OF USE OF SAME DUE TO DEFECTS OR AVAILABILITY OF SAME DURING SERVICE.

In case you have to send your TWO NOTES AUDIO ENGINEERING product to any other location, it is of vital importance to retain the original packing materials. It is very difficult to avoid damage if shipping the product without these materials. OROSYS SAS is not responsible for damages to the product due to improper packaging and reserves the right to charge a reboxing fee for any unit returned for service without the original packing materials. THE FOREGOING CONSTITUTES THE ONLY WARRANTY MADE BY OROSYS SAS WITH RESPECT TO THE PRODUCTS AND IS MADE EXPRESSLY IN LIEU OF ALL OTHER WARRANTIES EXPRESSED OR IMPLIED

2. Recommendation on the proper use of a loadbox with a tube amplifier

2.1 What is a loadbox?

In the normal use of a tube amplifier, it is highly recommended that you always connect its power output to a speaker cabinet prior to powering it up. The speaker cabinet (4, 8 or 16 Ohms) must

always be connected to the corresponding speaker output of your amplifier. Not doing so can lead to partial or complete destruction of the output stage of the tube amplifier.

Most tube amplifiers makers protect their products with fuses or other protection systems, however some amplifiers are still insufficiently protected. It is impossible to predict the behavior of all the amplifiers on the market in case of use without a load (a speaker cabinet or a loadbox).

The electronic term that describes the speaker cabinet with respect to the amplifier is the "load": we say the cabinet "loads" the amplifier. The term "loadbox" is used to describe any product that provides a load to the amplifier. The main parameter of the loadbox is its impedance, expressed in Ohms. An 8-Ohm loadbox must be plugged to the 8-Ohm speaker output of the amplifier.

The power sent to the load is turned into heat, so please follow the cooling recommendation in the manual — otherwise overheating may cause damage, both to the loadbox and to the amplifier.

The Torpedo Live is a digital loadbox. This term indicates that the Torpedo Live is a load which can electrically replace the speaker cabinet while dissipating (transforming into heat) the power coming out of the amplifier.

Within the Torpedo Live is a Reactive load. A Reactive load simulates the complex impedance of a real speaker.



Always connect the speaker out of your tube amplifier to an appropriate load (speaker cabinet or loadbox). The Torpedo Live, once powered up, is such a load. Please note that you should always power up the Torpedo Live before your amplifier. The maximum admissible power of the Torpedo Live is 100W RMS, your amplifier shouldn't be set to play at a higher output power value. See [this article](#) if your amplifier is more powerful than 100W.

2.2 Which output volume for my amplifier?

The correct use of your amplifier with a loadbox requires some precautions. Because of the silence while playing, it is much easier to accidentally run your amplifier beyond the reasonable limits set by the manufacturer than when using a real speaker cabinet with it. This can lead to faster tube wear and, in some cases, to more serious inconveniences.



When first testing the amplifier at high volume, monitor the color of the tubes and the general state of the amplifier. Red-glowing tubes or any appearance of smoke are signs of a problem that may result in partial or complete destruction of the amplifier.

Keep in mind that the "sweet spot" - the perfect running point of the amplifier, the one that will give you the tone you're looking for - is rarely obtained at maximum volume. In addition, the volume control of the amplifier is usually logarithmic, which means the volume goes up quickly on the first half of the potentiometer rotation, reaches its maximum at 12 o'clock, and doesn't change much beyond this point. Therefore, you can reach the maximum volume of your amplifier even if the volume potentiometer is not set at maximum.

By reaching the maximum output power of your amplifier, you will hear a lot of distortion, which may not sound as well as you may hope. In fact, most amplifiers sound rather poorly at maximum volume. Always keep in mind that your amplifier may not have been conceived to be used at maximum volume for a long period of time. Running an amplifier at high volume will cause premature wear of the tubes and possible malfunctions or damages at the output stage.



The fact that the volume control of your amplifier is not set at maximum doesn't mean your amplifier is not running at maximum volume. A good habit is to keep the usual volume setup you would use in rehearsal or on stage, rather than just following what the volume potentiometer indicates.

2.3 Is the use of a loadbox totally silent?

We usually talk about "silent recording" when a loadbox is involved. If we compare the loadbox solution to a traditional cabinet miking solution, it is obviously A LOT quieter. Noises that you may have not been able to hear before due to the volume of the speaker cabinet will now be more apparent. Here are a few of those sounds that you might have to take into account:

- Your guitar or bass strings can be heard. If you are not used to this, it could be initially distracting, depending on your environment.
- You may hear some noise coming out of your Torpedo Live when playing, like there is a tiny speaker inside the box. This is perfectly normal and there is no reason to worry. The sound is produced when power goes through the coil of the reactive load embedded on the Torpedo Live. The vibration is related to what power comes out of the amplifier connected to the Torpedo Live and to the signal's frequency content (notes played are heard). Your amplifier, specifically the output transformer of your amplifier, may also produce similar noise. Such noise is usually not heard, simply because it is normally obscured by the sound coming from the loudspeaker.
- The Torpedo Live has a built in fan, as there is quite a lot of power dissipated into heat inside the box. We selected a so called "silent fan", but as it is running fast, it is never entirely silent. This said, you can consider that, in normal use (hearing your guitar through monitors, or headphones), you can barely hear the fan.

3. About the Torpedo Live

3.1 Introducing the Torpedo Live

Two notes Audio Engineering is proud to introduce the Torpedo Live, the optimized for live playing version of the critically-acclaimed Torpedo hardware series. This product has been developed through years of technical research, with great attention to the needs of guitarists, bassists and sound technicians confronted with the challenges of miking instrument amplifiers, on stage or in the studio. Our goal is to provide ease of use, reliability, versatility and above all, perfect audio quality.

The Torpedo technology was created as an answer to the high pressure musicians have to deal with:

lack of time, limited gear availability, loud amplifiers that can't be played at desired volume, as well as bulky and heavy cabinets to carry. In addition, many musicians are more comfortable with their analog amplifier and effect pedals, and don't want to perform using digital modeling systems, which may compromise their playing style and sound.

For them, the Torpedo Live offers a "virtual" alternative to traditional miking, using a technology derived from the convolution reverberation, to achieve a degree of realism never experienced previously with simulators. The musician simply plugs the Torpedo Live in place of his cabinet, connected to the speaker output of his amplifier, without modifying his usual settings (or connected effect pedals as applicable).

The Torpedo Live comes with a large library of 32 cabinets and 8 microphones among the most commonly used models in the world. You can also upgrade and add many other cabinets through "La Boutique", our online virtual cabinet store. The virtual miking is achieved by choosing one cabinet and, depending of the mode used, one or two microphones, and fine-tuning the position of each microphone in front of the cabinet. The Torpedo Live allows the user to assume the role of the sound engineer in a professional studio.

The Torpedo Technology: to bring you realism and playing comfort, Two notes has developed a unique technology based on an adaptation of convolution techniques. Starting with the measurement of an actual cabinet + microphone setup, the Torpedo Live can accurately reproduce the system as it was measured, as well as the microphone's position in space. In order to take full advantage of these digital algorithms, the highest quality audio design assures a perfect analog-to-digital conversion and a huge dynamic range to retain the ultimate playing experience.

This product has been thoroughly tested in professional studio and stage environments and is the alternative many musicians were waiting for, to achieve a professional sound capture of their amplified instruments. The Torpedo Live will give you the elusive sound of the greatest recording studios and producers, anytime, anywhere.

3.2 Front panel



- | | | |
|---------------------|-----------------------------|---------------------|
| 1. Ventilation slit | 4. SETUP button | 7. EDIT/SAVE button |
| 2. Input gain | 5. PRESET/PARAMETER encoder | 8. Phones output |
| 3. Display | 6. OUT LEVEL/VALUE encoder | 9. Mains switch |

3.3 Rear panel



- 1. Mains power
- 2. Serial number
- 3. USB
- 4. MIDI
- 5. S/PDIF In/Out
- 6. Balanced line output
- 7. Balanced line input
- 8. 8 Ohms load warning
- 9. Speaker output
- 10. Amplifier input
- 11. Fan

3.4 Only A Speaker Simulator?

The Torpedo Live is a standalone unit you can bring with you in any situation, whenever silent playing is needed.

The role of the Torpedo Live is to replace the following elements of the traditional guitar or bass setup:

- the guitar/bass power amplifier
- the speaker cabinet
- the microphone
- the microphone preamplifier

In order to provide a signal that is the closest possible to a traditional guitar/bass miking in a professional studio environment.

The miking is achieved in 3 steps with the Torpedo Live:

1. Choose a power amplifier (or switch it off if you are using a loadbox), a speaker cabinet and a microphone (Power Amp, Speaker, and Microphone sections)
2. Position the microphone inside the virtual studio (Miking window and parameters)
3. Shape the signal (EQ, Reverb sections)

At each step, Two notes Audio Engineering implements its know-how to offer the most advanced simulations on the market and ensure absolutely realistic quality both for the musician (in terms of playing sensation) and for the listener (in terms of sound quality). You can load up to 32 Two notes cabinets in the Torpedo Live. Download the free Torpedo Remote software (Mac OS X and Windows PC) from the [Two notes Audio Engineering](http://www.two-notes.com) website, and you will be able to add or remove the stored cabinets. There are currently more than 80 Two notes cabinets available in La Boutique and the Two notes Store that you can try in real time and purchase with Torpedo Remote (requires a working Internet connection).

3.4.1 Tube Stage Output

When using guitar/bass preamplifiers with some other speaker emulators, the musician may feel they miss a power amplifier's contribution to the overall sonic texture. Many musicians get their sound from a particular use of that element and the Torpedo Live gives you the possibility to use it too. To that effect, Two notes Audio Engineering has developed an original tube-stage modeling that gives you a choice of 4 different tube models (6L6, EL34, EL84 and KT88) in Push-Pull (PP) in AB class, or Single Ended (SE) in A class configurations. You can push this tube stage like a conventional amplifier and look for that subtle yet particular distortion.

The Torpedo Live can be used as a super-DI for keyboards. The tube-amp simulation feature, developed for guitarists and bassists, can also be a very interesting device to warm up the sound of a synthesizer, an organ, or a digital piano.

3.4.2 EQ Section

When recording guitars or basses, it is common to apply a few effects to shape the sound before sending it to a PA or a recorder. In the Torpedo Live you will find a simple but efficient EQ filter with two modes, GUITAR or BASS.

3.4.3 Room reverb

One of the latest additions to our Torpedo firmware is a room reverb. When recording a guitar or a bass, the room sound is really important, especially with distant miking. With the Torpedo Live, you get the option to choose how the record room sounds!

3.4.4 The Torpedo technology, convolution and Impulse Responses

The impulse response (IR) of a system describes its behavior under the form of a very detailed filter. The convolution technique uses IRs to simulate the behavior of particular systems, such as reverbs, speakers, EQ...

It is the most accurate way to simulate sound signatures that are linear (i.e. without distortion) and timeinvariant (i.e. without modulation, compression, hysteresis...). It is particularly well suited for speaker miking simulation.

Two notes has developed a unique technology based on an adaptation of convolution techniques. Starting with a measure of a real cabinet + microphone setup, the Torpedo Live can accurately reproduce the system as it was measured, including the microphone's position in space by using IR synthesis.

3.4.5 3rd Party Impulse Responses

The Torpedo Live is capable of delivering the best guitar and bass tones by using the Torpedo technology, but you can also embed impulse responses that you have purchased or downloaded for

free from 3rd-party developers, in WAV or AIFF formats. You can upload third-party IRs in the Torpedo Live, by way of the free Torpedo Remote software.

3.4.6 Create Your Own IR's

Download the free Torpedo BlendIR software from the [Two notes Audio Engineering](#) website. With this software you will be able to capture your own cabinet + microphone setup and embed its sound signature into the Torpedo Live.

4. Connecting the Torpedo Live

The Torpedo Live is a digital loadbox designed to offer a solution for silent and quality sound pick-up in many situations (home, stage, studio) with an amp or a preamp. The following illustrations show the different common situation the Torpedo Live has been created for.

4.1 With an amp

Torpedo Live With an amp.

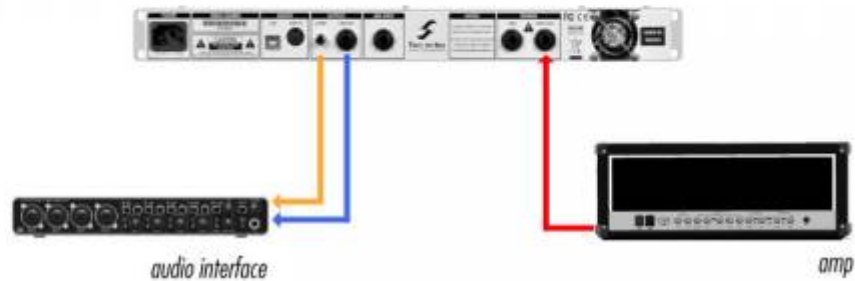

Record silently

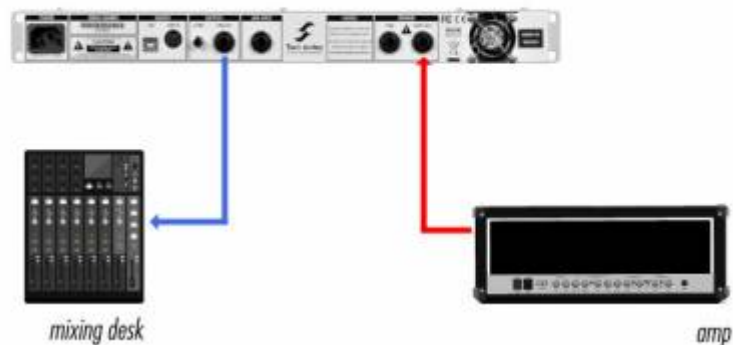

- = digital cable (SPDIF)
- = balanced cable (XLR or TRS jack)
- = speaker cable (only use cables that are labeled as such)

Perform silently



| | |
|---|--|
|  | Please keep in mind that tube amplifiers have to be connected to an appropriate load (cabinet or load box). Always plug the 8 ohms output from your amp to the 8 ohms input of the Torpedo Live. |
|  | Always use a standard speaker cable between the amplifier speaker out and the Torpedo Live SPKR IN. A speaker cable and an instrument cable may look similar. You may have to open the jack connector and see for yourself: the speaker cable is unshielded and carries the powerful signal through two insulated conductors, the instrument cable is shielded and has only one internal conductor. Using an instrument cable instead of a speaker cable can cause significant damage to your amplifier, requiring service by a technician. |

Primarily designed for stage use, The Torpedo Live also fits perfectly in a digital or analog studio setup, to bring you the greatest tone with your amp, whatever the circumstances. You can either connect to the audio interface with the line Output or the SPDIF output.

Torpedo Live Using SPDIF.

 = digital cable (SPDIF)



Plug your 8 ohms out on your amplifier to the SPEAKER input of the Torpedo Live. Connect the S/PDIF OUT of the Torpedo Live to the S/PDIF IN of your audio interface. The sampling frequency can be set to 48KHz or 96KHz.

The biggest benefits of using the SPDIF is to record both a DRY signal of the amp and a WET signal of the whole signal chain (with speaker simulation) out of the Torpedo Live. An S/PDIF signal contains two audio channels. The Torpedo Live is a mono unit, so we decided to give a great feature : sending the WET signal (with miking simulation) through the LEFT channel and the DRY signal (without miking simulation) on the RIGHT. This way you can record the dry and wet signal simultaneously. Use the Wet signal to play as usual, and the DRY signal from the amp with a plugin speaker simulator, such as our Torpedo Wall of Sound plugin. You can decide to use both channels to carry the Wet or the Dry signal, please read about the Output parameter in the Setup menu. In this configuration the Torpedo Live is the master of the S/PDIF communication. This way, analog to digital conversion is handle by the Torpedo Live, so you preserve all the tone coming from your preamp/amp.



For a working S/PDIF connection, your audio interface must be in slave mode, while the Torpedo Live is in master mode. Your audio interface must handle 48KHz and/or 96KHz to properly work with the Torpedo Live. For more information on your audio interface, please refer to its user manual.

Control the machine from your computer (PC Windows or Mac OSX) with the Torpedo Remote software in USB. Create, save and load presets, load new cabinets or Impulse Response (IR) files. Download the Torpedo Remote for free on the [Two notes Audio Engineering](http://www.two-notes.com) website.

4.2 With a preamp

Torpedo Live With a preamp.

Record silently

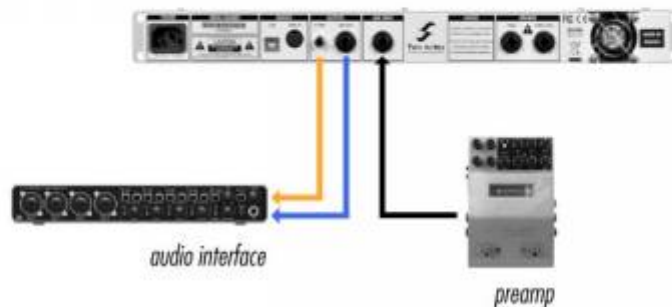

- ← = digital cable (SPDIF)
- ← = balanced cable (XLR or TRS jack)
- ← = instrument cable (TS jack)

Perform silently

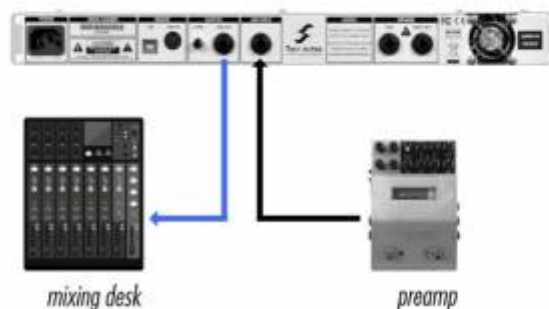

The Torpedo Live can be used with a preamp instead of an amp. To do so, connect the preamp to the Line Input of the Torpedo Live. The Line Input has priority on the Speaker input. Meaning, if a cable is connected to the Line Input, the Speaker input is disconnected.



By pluggin a 1/4" jack into the Line input, you disconnect the Speaker input signal. It is safe if you have an amplifier connected on the loadbox, but only the signal coming from the Line input will be processed and be heard at the output.

The analog I/O of the Torpedo Live offers great options on stage. For example, the analog output can be connected to the front mixing console. Or plug headphones to the appropriate output and enjoy playing your amp LOUD at home in total silence.

With a MIDI foot controller, you gain access to the presets navigation and even parameter changing in real time.

Torpedo Live Using MIDI.

 = MIDI cable

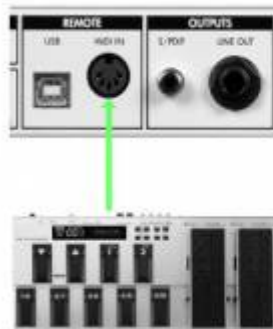

The Torpedo Live handles both Program Change et Control Change commands. See section 6 of this manual for the complete MIDI guide of the Torpedo Live.

Playing in silence is a great feature, but at some point you have to listen to what you play! We present a few options to use at home, in the studio or on stage:

1. Listen through the headphones out,
2. Listen on a guitar/bass cabinet plugged to the Torpedo Live THRU output,
3. Having a local monitoring system on stage, by duplicating the LINE OUPUT with a mixer,
4. Having in-ear monitors or wedge speakers controlled by a sound engineer.

| | |
|--|---|
| | The THRU, S/PDIF and LINE outputs can be used simultaneously. |
| | When you plug a cabinet to the THRU output, the impedance of this cabinet is the one that your amplifier sees. In other words, with a 4 Ohms cabinet, you need to connect the 4 Ohms output of your amplifier. In this configuration, the load box inside the Torpedo Live is disconnected. This way, you can override the 8 Ohms only limitation of the Torpedo Live. |

4.3 Stay connected

You may have discovered an idea to use the device in some innovative way. Do not hesitate to come and share your experience on the Two notes Audio Engineering Forum or social networks. Please go to the [Two notes Audio Engineering](http://www.two-notes.com) website and click on the "Community" section.

Two notes is also on the social networks [Facebook](https://www.facebook.com/twonotes), [Soundcloud](https://www.soundcloud.com/twonotes) and [Youtube](https://www.youtube.com/twonotes) — so do not wait and come share your creative work!

5. Configuring and using the Torpedo Live

5.1 The Torpedo Live interface

The Torpedo Live parameters are organized in menus, accessible by different push-buttons and knobs as seen in [figure 3.2](#).

- Two 2-function rotary encoders: PRESET/PARAMETER, OUTPUT LEVEL/VALUE
- Two push-buttons: SETUP and EDIT/HOLD TO SAVE.
- One potentiometer: IN LEVEL.

When pushing a button or turning an encoder, you will see a parameter moving on the display.

5.2 Input gain control

The IN LEVEL potentiometer controls the input gain of the unit. The Torpedo Live being a digital product, it is absolutely critical to avoid any saturation of the input signal and avoid the risk of considerably reducing the audio quality. The input level is controlled by a potentiometer and is the same for all presets. To get the best sound, try to have the same volume (or close) on all different sounds coming to the Torpedo Live. This way you won't have to change the input gain when switching the channels on your amplifier. If you don't have individual volume settings on your amplifier channels, always do the gain setting with the loudest channel.

The input gain adjustment must be done with input signal present at the input selected (speaker or line input). The input bargraph gives you a visual indication of the input signal amplitude. The upper red led is on when there is saturation in the input stage: lower the volume of your amplifier output and/or lower the input gain.



For optimum quality, we advise to keep the peak levels of the input signal at a maximum of -12dB to -6dB on the bargraph.

5.3 Three menus: PERFORM, EDIT & SETUP

The Torpedo Live has three different menus, giving you access to different parameters:

1. Navigate through the 128 presets in PERFORM menu
2. Edit a preset in EDIT menu
3. Setup global parameters of the unit in SETUP menu

To enter a menu, whatever the current menu, push the appropriate button. To see and modify the various parameters, use the appropriate encoders which function depends on the current menu.

5.4 PERFORM

The PERFORM menu is the default menu you will see when first using the Torpedo Live. The following information will be displayed on the screen:



- First line: preset name, preset type (Arcade (A), Simulation (S) or IR Loader (I)) and number (between 001 and 128.)
- Second line: Cabinet name (or IR name) and output volume (OUT LEVEL between -95dB and +12dB).

In this menu you can navigate in the presets and set the output volume of the unit. You will be in this menu when playing without editing or modifying any parameter. This way you can have a fast access to the volume in case you have to quickly lower or increase the volume in any situation.

We recommend first to search for a preset close to the sound you have in mind, then tweak the selected.



The preset name is limited to 32 letters or numbers. The authorized characters are capital A to Z, 0 to 9 and space.

The various functions of the buttons in PERFORM menu are described in the following table:

| Button | Function |
|-----------------------------------|-----------------------|
| SETUP | Switch to SETUP menu |
| PRESET/PARAMETER | Navigate the presets |
| OUT LEVEL/VALUE | Set the output volume |
| HOLD TO SAVE/EDIT (hold) | Save a preset |
| HOLD TO SAVE/EDIT (toggle) | Switch to EDIT menu |

5.5 EDIT

In the EDIT menu, you will have access to all the parameters of a preset, allowing you to modify it, or create your own tone from scratch.

To enter the EDIT environment from the PERFORM environment, press the EDIT button on the front panel.

All starts with the first section, which allows you to chose which mode you will be working in : Arcade, Simulation or IR Loader.

You can choose between two preset modes: **Arcade or Simulation**. We borrowed the concept of **Arcade VS Simulation** from the world of video games.

The **Arcade** mode is usually the easy way to, for example, drive a race car. You can hit obstacles, other cars, you can still win the race. We recommend that for your first experience with The Torpedo Live you start with the Arcade preset mode to get more familiar with the concept of virtual miking.

The **simulation** mode is not for beginners and requires more experience and knowledge about how the car actually works, depending on many tiny but still important parameters (weather, type of tires, track design...). In that preset mode you will gain access to the full list of parameter, to fine tune your sound and make it perfect to your ears.

The various functions of the buttons in EDIT menu are described in the following table:

| Button | Function |
|--------------------------|-------------------------------|
| SETUP | Switch to SETUP menu |
| PRESET/PARAMETER | Navigate the parameters |
| OUT LEVEL/VALUE | Modify the selected parameter |
| HOLD TO SAVE/EDIT | Save a preset between |
| HOLD TO SAVE/EDIT | Switch to PERFORM menu |

5.5.1 Arcade mode

In Arcade mode, the EDIT menu displays all the Arcade parameters, followed by the output volume of the preset (this volume setting is saved with the preset, so you can adjust the levels in order for the presets to be at comparable volumes).

Navigate through the parameters with the PARAMETER encoder. On a parameter page, you will see the name of the parameter and its value. Change the value using the VALUE encoder.

In the simplified interface of the Arcade mode, each parameter actually controls one or several parameters of the Simulation mode. For more details on the Simulation mode, see its description later in this document.

The parameters of the Arcade mode are listed below.

5.5.1.1 Instrument

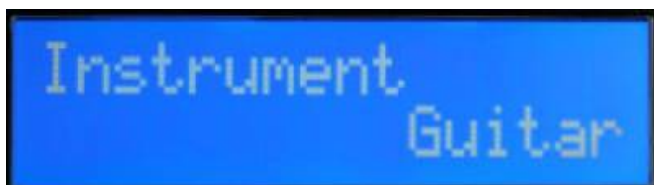

Guitar or Bass, it determines the type of speaker cabinet you can access to and select later, the power amp type and parameters and EQ characteristics of the Contour parameter.

5.5.1.2 Virtual cabinet

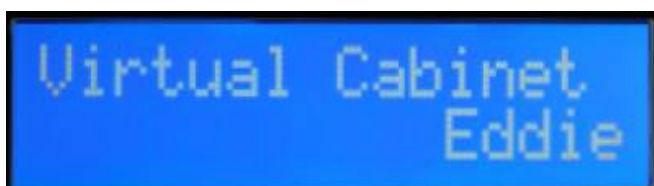

This section lets you choose your virtual cabinet through which you will be hearing your guitar. Changing the cabinet can drastically change your tone.

5.5.1.3 Mic

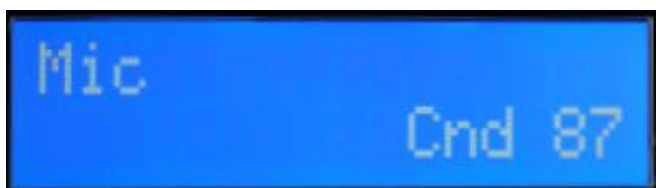

Here you will choose the microphone to pickup the sound from the cabinet. Each cabinet comes with a fix selection of 8 microphones. Note: in Arcade mode, you can only use one microphone per cabinet.

5.5.1.4 Room

To enhance you experience with the Torpedo Live, especially when playing with headphones, your unit features different reverbs.

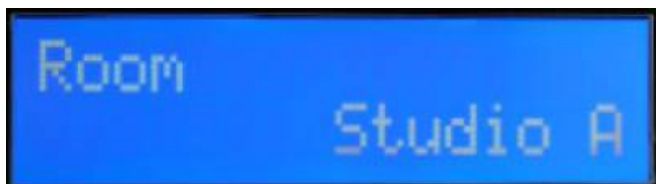

The room type determines the type of reverb you will apply to your guitar or bass tone. You have access to 8 different rooms: Studio A & B, Hall A & B, Cathedral, Crypt, Basement and Loft.

5.5.1.5 Power Amp

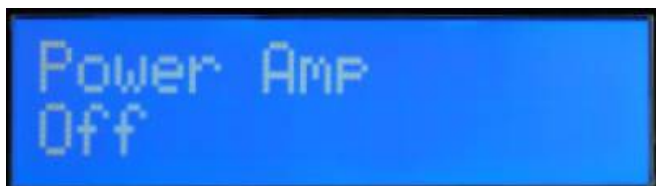

In Guitar mode we selected an EL34 Pentode PP power amp and a 6L6 Pentode PP power amp for Bass. Presence and Depth are fixed at 100%. The Power amp parameter determine the amp master volume, from Cold to Hot. it can also be turned OFF.



The Power amp parameter determine the amp master volume, from Cold (low power) to Hot (high power). it can also be turned OFF.

5.5.1.6 Tone



Miking tone, from Dark to Bright. Triggers the Center parameter, moving the microphone from the center of the speaker to the side.

5.5.1.7 Distance



In Arcade mode, Distance triggers both the mic placement algorithm (IR synthesis) and the Dry/Wet of the Reverb. The farther the microphone is from the cabinet, the more you will hear the reverb effect. The microphone is always placed in front of the cabinet.



5.5.1.8 Contour

Contour: EQ settings based on a loudness algorithm. Vintage will cut low and high frequencies while Modern will emphasize them. The EQ parameters depends on the Guitar/Bass setting.

5.5.1.9 Contour



Controls the level of the preset, from -95dB to 0dB.

5.5.2 Simulation mode

In Simulation mode, the EDIT menu features 4 modules (Power Amp, Miking, EQ and Reverb), followed by the output volume of the preset (this volume setting is saved with the preset, so you can adjust the levels in order for the presets to be at comparable volumes). Navigate through the parameters and/or modules with the PARAMETER encoder.

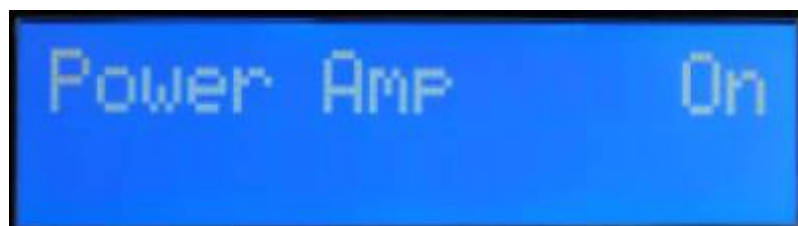

A module is activated when it's On, you can change the module state with the VALUE encoder. Once the module is On, you gain access to the module parameters.



On a parameter page, you will see on the first line the module name, the parameter index and the number of parameters of the module. On the second line you will find the parameter name and its value. Change the value using the VALUE encoder.

5.5.2.1 Power Amp

When using the Torpedo Live with any kind of guitar/bass preamplifier, or even an electric piano or a synthesizer, you need the color brought by the final stage of a traditional amplifier: the power amplifier. Plug your device to the LINE input of the Torpedo Live and enjoy the typical sound of the Two notes electrically accurate virtual tube power amplifier:



MODEL is the amplifier topology (Push Pull or Single Ended) and the tubes type (6L6, EL34, EL84 or KT88). TYPE selects how the tube is used, either in triode or in pentode mode. Pentode mode has more headroom and volume than triode.

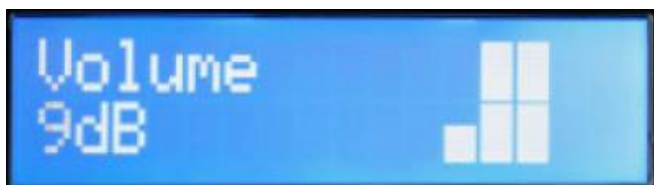

Set up the output volume of your virtual power amplifier. The volume at 0 is the same as switching off the Power Amp.



This setting affects the tube stage frequency (loudness), by adjusting the bass response of the power amp. The Presence at 100 does not affect the incoming signal, while at 0 the low end frequencies are cut drastically.



This setting affects the tube stage frequency (loudness), by giving more low end to the signal. The depth at 0 does not affect the incoming signal, while at 1000 the low end frequencies are boosted.

5.5.2.2 Miking

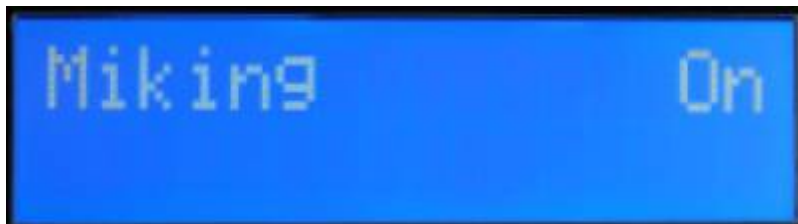

The MIKING section is where you will choose your virtual cabinet and the two microphones to do the miking.

You have access to 32 different cabinets and each cabinet can be miked with 2 of the 8 available microphones for the given cabinet (Mic A and Mic B).

First you choose your cabinet.

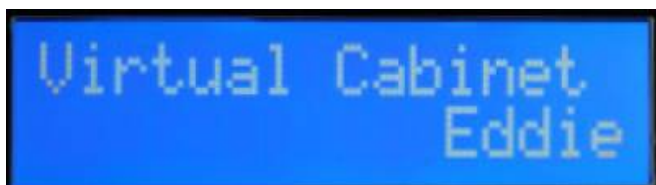

Then choose the 2 microphones you will use for Mic A and Mic B.



The next window sets levels, mute and phase for each microphone.



Note: all the microphone in all the Two notes Virtual Cabinets are already captured in phase with each others, so the Phase parameter is not needed to correct the relative phase of the two microphones. This parameter can rather be used to get a specific out-of-phase effect, or correct the phase between the Torpedo Live microphones and an external signal.

This window shows you how the mics are placed in regards of the cabinet, and this part will let you do the mic placement for each microphone with the following sequence of parameters.



- Axis : You will set the placement of the mic towards the cone of the cabinet's speaker. At 0% the mic is placed at the center of the speaker (leading to more treble), at 100% the mic is

placed either at the edge of the speaker (when the mic is at the grill cloth, giving a smoother sound), or up to 1 meter (3 feet) away from the center (when the mic is at the furthest distance of the cabinet).

- Dist : You will set the distance of the mic towards the cabinet. At 0% the microphone is placed at the grid cloth of the cabinet. At 100% the mic is placed at 3 meters (10 feet) from the cabinet.
- Side : You will place the mic at the Front or at the Back of the cabinet.

5.5.2.3 EQ



The EQ section is a simple yet powerful 5-band EQ. It has 3 mode of operations : guitar, bass and custom. Guitar and bass are centered around fix frequencies for each band, whereas custom mode is a semi parametric eq with an adjustable low cut filter.



120Hz, 360Hz, 800Hz, 2000Hz, 6000Hz (centre frequency of each band from the lower to the highest). You can adjust the gain for each band with a range of -20 dB to +20dB



50Hz, 120Hz, 360Hz, 800Hz, 4000Hz (centre frequency of each band, from the lowest to the highest). You can adjust the gain for each band with a range of -20 dB to +20dB



Instead of having fixed frequencies to work with, you have a 5 band semi parametric eq with a low cut filter. You will set the frequency then the gain for each band (except for the low pass filter)

5.5.2.4 Reverb



To enhance your experience with the Torpedo Live, especially when playing with headphones, your unit features a room reverb.



The room type determines the type of reverb you will apply to your guitar or bass tone. You have access to 8 different rooms: Studio A & B, Hall A & B, Cathedral, Crypt, Basement and Loft. The Dry/wet setting determines the amount of reverb to be applied to your tone.

5.5.3 IR loader

This mode is solely dedicated to third party IRs. The Torpedo Live allows for the use of IRs which are up to 40 ms long.

The interface of the IR Loader mode is similar to the Simulation mode. It differs only in the Miking section. For a description of the other sections, see the Simulation mode description above.

5.5.3.1 Miking

The MIKING menu is where you will choose the IRs you want to use. Just like in simulation mode where you can dual mike a cabinet, you will be able to select 2 IRs to be used at the same time.

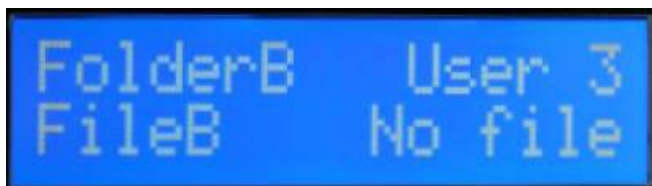

You have access to the Folder where you will then select an IR. First you choose your folder where you will be browsing the IRs you need. Then the IR file you will use.



The next window will let you set levels, mute and phase for each IR.

5.6 SETUP menu

| Button | Function |
|-----------------------------------|-------------------------|
| SETUP | Return to PERFORM menu |
| PRESET/PARAMETER | Navigate the parameters |
| OUT LEVEL/VALUE | Set a parameter value |
| HOLD TO SAVE/EDIT (hold) | Save a preset |
| HOLD TO SAVE/EDIT (toggle) | Switch to EDIT menu |

Whether you are in EDIT or PERFORM menu, click on the SETUP button to enter the SETUP menu. The SETUP menu groups all the global parameters of the Torpedo Live. In this menu, you will be able to monitor information, such as the reception of a MIDI command or the syncing of the unit with the Torpedo Remote as well as the selection of desired settings and preferences.

| Parameter | Value |
|--|--|
| MIDI CC Control MIDI PC Program MIDI CHANNEL MIDI MONITOR | Control Change receive, On or Off Program Change receive, On or Off MIDI Channel selection, from 1 to 16 or ALL (the unit listens to all MIDI channels) Incoming MIDI command monitoring <ul style="list-style-type: none"> • “- -”: a command is received on a MIDI channel different from the one you selected for the unit. • “In”: a command is received on the channel you selected for the unit. |
| REMOTE MONITOR | <ul style="list-style-type: none"> • No Connection: no active USB connection • USB Connected: active USB connection • Remote connected: active USB connection, sync with the Torpedo remote |
| OUTPUT | The Torpedo Live is a mono unit, but the S/PDIF digital output carries 2 channels: the Wet (meaning with speaker simulation) or Dry (meaning without speaker simulation) signal, or a combination of the two. It is important to note that the LEFT S/PDIF channel and the Line/Headphones output of the Torpedo Live are fed by the same signal. In other words, when the LEFT S/PDIF channel carries the DRY signal, the Line and Headphones output will carry the DRY signal too. When the LEFT S/PDIF channel carries the WET signal, the Line and Headphones output carries the WET signal. |
| OUTPUT (2nd row) | Selection of the S/PDIF output frequency (48KHz or 96KHz) |
| Firmware Serial | Current firmware version of the unit Serial number of the unit |

5.7 MIDI setup

The MIDI parameters can be found on the SETUP menu. The Torpedo Live handles both preset change commands (Program Change or PC) and parameter change commands (Control Change or CC). This way, you can interact with all the parameters on the unit from any kind of standard MIDI controller, like a MIDI pedalboard or a keyboard.

1. Select if the unit is to receive to Program Change and/or Control Change commands. For example, if you plan to use the preset switching (PC), the CC receive can be Off.
2. Set a MIDI channel for the unit to receive. You can choose to receive all channels, which is useful when you don't know exactly on which channel the commands are sent.
3. With the MIDI monitor, check the correct reception of the commands by the Torpedo Live.

5.8 Continuous save, preset save

The state of the unit is saved in real time, continuously, and is reloaded when you switch on the unit. The parameters continuously saved are:

- the current preset,
- the modified preset if any (with all its parameters and name),
- the SETUP menu parameters,
- and the OUT LEVEL.

The navigation is not saved (for example if you were in a particular parameter menu). The purpose is to reload the unit at its initial state, after a power outage on stage, for example.

When you edit a preset, a star can be seen after the preset number in PERFORM menu. It is possible to navigate through the presets and to come back to the preset you are editing. This way, the modified and the non-modified preset can be compared. If you edit a second preset, this will cancel the modification on the first edited preset if it was not saved. It is only possible to edit one preset at a time.

Saving a preset can be done from any menu, by holding the HOLD TO SAVE/EDIT button. The saving process is done in three steps:

1. **“Rename & hold...”**: Choose the preset name, use PARAM to change the character position and VALUE change the character. Hold the button to go to the next step.
2. **“Hold to save to:”**: Choose where you want to save the preset, the default slot is the current one. Hold the button to go to the next step.
3. You will see on the screen **“Saving, please wait...”** for less than a second, the preset is now saved.

5.9 Torpedo Remote

With the standalone software Torpedo Remote, take control of the unit via USB, change the parameters, arrange or add/delete cabinets and IR files, and apply updates. Torpedo Remote will detect any new update or new Two notes cabinets (it requires a working Internet connection).

You can download Torpedo Remote for Windows™ and MAC OSX™ from the [Two notes Audio Engineering](#) website.

Like the hardware rack, the Remote is arranged around the 3 modes : Arcade, Simulation and IR Loader. Here are the different layouts.

Arcade mode with the simplified rack and one microphone to move around the cabinet.



The Simulation mode gives you access to all parameters and the two microphones, which can be placed at the front or the back of the cabinet.



The IR Loader mode gives you quick access to the 2 IRs you can use simultaneously, with a bigger display to visualize the complete name of the files.



The Remote allows you to easily organize your Two notes virtual cabinets, your presets and your third party IRs.

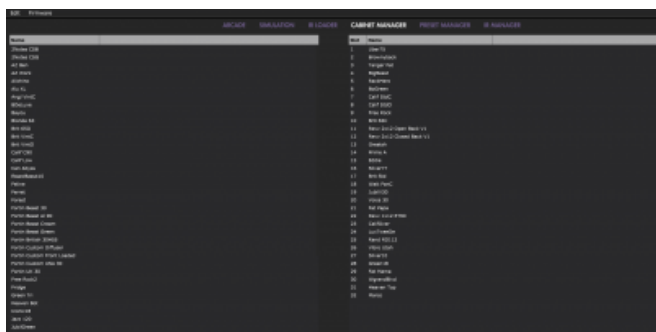

In the Cabinet Manager window, you can visualize on the left side the cabinets that are available in your license and on the right side what cabinets are loaded in the pedal. you can drag and drop your cabinets from the left side panel (the computer side) to your Torpedo Live (the right side panel). If ever the 32 memory slots are full in the Torpedo Live, you need to free space by dragging and dropping any cabinets to the bin.

The PRESET MANAGER window allows to drag and drop presets from the computer to the

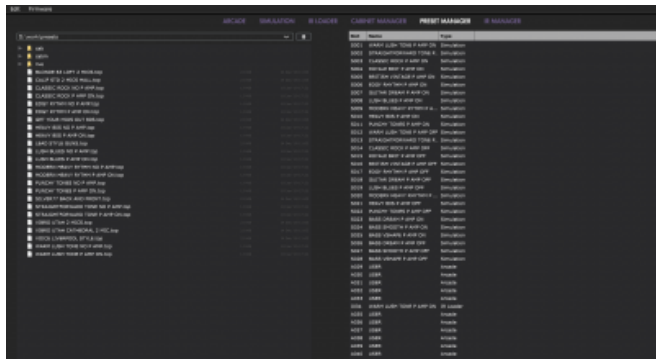

Torpedo Live.

The installation process of the Torpedo Remote software creates a folder where the Two notes virtual cabinets are stored :

- “%APPDATA\Two notes Audio Engineering\Cabinets” on Windows™
- “~/Library/Two Notes Audio Engineering/Cabinets” on MAC OSX™

Torpedo Remote automatically downloads and saves the Two notes virtual cabinets in this folder.

A “Two Notes Audio Engineering” folder is created in the **Documents** folder of the user. This folder contains:

- a “Presets” folder containing a copy of all default presets installed in the C.A.B M.
- an “Impulses” folder that can be used to store your IR files.

These two folders are used by default by the Preset Manager and the User IR Manager of the Torpedo Remote.

To load a Two notes virtual cabinet, a .tur file or a 3rd party IR in the Torpedo, use the Memory Manager of Torpedo Remote.

5.10 Want more cabs?

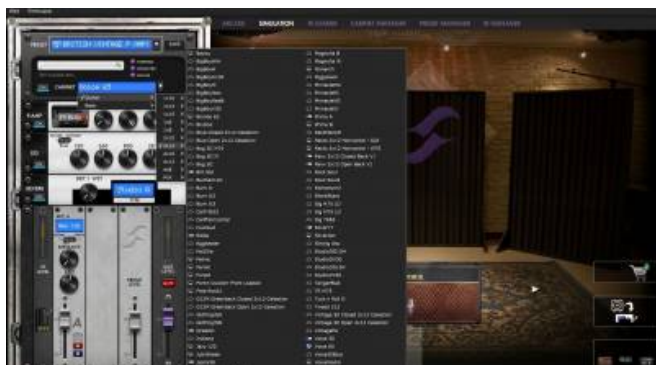

You can preview any cabinets that are not in your licence when using the Remote. This is why when you browse the cabinets in the Remote the list is way bigger than what you have in your licence or in your Torpedo Live when the buttons Torpedo, Computer and Online are selected (next to the search bar).

You will see 3 types of icons in front of the names of the cabinets :

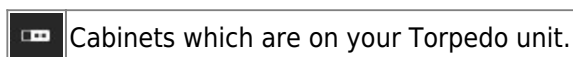

 Cabinets which are on your licence loaded in your computer

 Cabinets which you do not own but can preview before buying them on the Two notes Store.

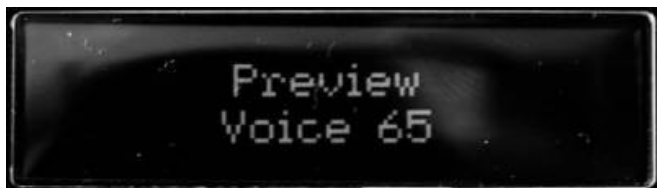

The Torpedo unit will show « Preview » on the screen when previewing a cabinet in the Torpedo Remote.



This box allows you to transfer the cabinet you are previewing from your computer to your Torpedo unit (as long as you have memory slots available in your unit).

When you are previewing a cabinet that you do not own, random silences are inserted and you have access only to one mic to preview the cabinets.



The Torpedo unit will show « La Boutique » on the screen when previewing a cabinet from the Two notes Store in the Torpedo Remote.

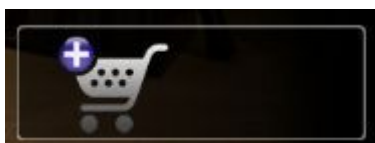

You can add the previewed cabinet in the Store Cart by clicking on the trolley with the plus sign.



This operation can be repeated for any cabinets, and when you want to finalise the cart and buy the cabinets you want, you click on the trolley with the green tick and you will be taken to the online Two notes Store. The trolley with the minus sign allows you to remove the current cabinet from the cart :

No billing or information on the payment method is stored on the Remote, so as to ensure maximum security.

5.10.1 Which cabinet is the right one for me?

The Torpedo Live comes with 32 cabinets, for bass and guitar. Among these cabinets you will find

some that you know, others that you should know, and maybe the hidden gem that will work for you and you had no idea. To work faster, you should make sure the EQ, reverb and anything apart the cabinet and microphone are turned off so you can concentrate on that part of the process.

Please try the cabinets without too much preconceived idea about what you think you need. Often, the solution comes from a cabinet you wouldn't think of. As a general guide, we recommend using small sized cabinets for more mids and high frequency, they are good fo solos and clean tones. Use the big boys on distorted and/or or rhythm guitars.

5.10.2 Which microphone is the right one for that cabinet?

You will find a selection of 3 types of microphones with each Two notes cabinet: condenser, ribbon and dynamic. The microphone technology gives an idea on how it will sound, even if, with each technology, you could find microphones that are not sounding as you might expect.

- With the Torpedo Live, you will choose a ribbon microphone if you need a smooth, creamy tone. They are perfect when the guitar or the bass is in a light mix (meaning without tons of other instruments or distortion). We always recommend that type of microphone for the guitarist or bassist who is approaching miking techniques for the first time, they will sound very close to what you hear on your traditional guitar or bass cabinet.
- Condenser microphone usually give wide bandwidth and great details in the upper frequency. Very good on bright clean tones, they also excel at helping fit a distorted guitar in a mix.
- Dynamic microphones are what you usually find on stage because they are sturdy and reliable. They usually give good detail in the mids, but they are not as subtle as ribbon or condenser microphones.

Take the time to try them, and learn more about the different types of microphones to anticipate what you need, depending on your amp and cabinet tone, and of course the type of tone you aim at having on stage or in the studio.

5.10.3 .tur files

.tur are proprietary files created with the Two notes Audio Engineering Torpedo BlendIR software. The software is available for download from the [Two notes Audio Engineering](#) website. With Torpedo BlendIR you are able to use the Torpedo technology to capture the sound signature of your own cabinet and microphone in the deepest details.

To load a file into the Torpedo, place it in the default *Impulse* directory, or select the directory containing the files through Torpedo Remote (this can be done in the menu). You can then load the files into the Torpedo through the Memory Manager or directly listen to them through the main Remote window.

Please note that with .tur files you do not have access to the microphone positioning parameter.

5.10.4 3rd-party IR files (in .wav or .aiff format)

Torpedo Live complies with third-party Impulse Responses (IRs) in .wav or .aiff format.

To load a file into the Torpedo, place it in the default *Impulse* directory, or select the directory containing the files through Torpedo Remote (this can be done in the menu). You can then load the files into the Torpedo through the Memory Manager or directly listen to them through the main Remote window.

Note: with 3rd-party files you do not have access to microphone positioning parameters.

6. MIDI

Your Torpedo Live can receive MIDI Program Change (PC) and Control change (CC) commands sent by any kind of MIDI controller connected to the MIDI IN of the machine.



It is important to setup the Torpedo Live so it will be listening to the MIDI control commands. Please refer to part 5.6 of this manual.

6.1 Program Change (PC)

Each preset on the Torpedo Live has a single program number. The preset 001 of the machine is triggered by a MIDI PC 1, you can address the 128 presets, with MIDI PC 1 to MIDI PC 128. This way, it is possible to randomly access the preset by sending the appropriate MIDI PC number.

6.2 Control change (CC) - For V3 firmware

The following table indicates the Control Change numbers for every parameter, as well as their range and behavior. This table is valid for firmware version 3.

| Parameter | CC# | Range | Behavior |
|------------------------|-----|-------|--------------------------------|
| Simulation mode | | | |
| Power Amp | | | |
| On/Off | 0 | 0-1 | 0 = Off ; 1 = On |
| Model | 1 | 0-7 | 0 = Model #0 ; 1 = Model #1... |
| Volume | 2 | 0-30 | 0 = 0dB ; 30 = 30dB |
| Presence | 3 | 0-127 | 0 = 0% ; 63 = 50% ; 127 = 100% |
| Depth | 4 | 0-127 | 0 = 0% ; 63 = 50% ; 127 = 100% |
| Type | 5 | 0-1 | 0 = Triode ; 1 = Pentode |
| Miking | | | |

| Parameter | CC# | Range | Behavior |
|--------------------|-----|-------|---|
| On/Off | 6 | 0-1 | 0 = Off ; 1 = On |
| Mode | 7 | 0-7 | 0 = Cab/Mic ; 1 = User 0 ; 2 = User 2 ; 3 = User 2 ; 4 = User 3 |
| Cab | 8 | 0-x | 0 = Cab #0 ; 1 = Cab #1... |
| User 0 | 9 | 0-x | 0 = File #0 ; 1 = File #1... |
| User 1 | 10 | 0-x | 0 = File #0 ; 1 = File #1... |
| User 2 | 11 | 0-x | 0 = File #0 ; 1 = File #1... |
| User 3 | 12 | 0-x | 0 = File #0 ; 1 = File #1... |
| Mic | 13 | 0-7 | 0 = Mic #1 ; 1 = Mic #1... |
| Distance | 14 | 0-127 | 0 = 0% ; 63 = 50% ; 127 = 100% |
| Center | 15 | 0-127 | 0 = 0% ; 63 = 50% ; 127 = 100% |
| Position | 16 | 0-1 | 0 = Back : 1 = Front |
| EQ | | | |
| On/Off | 17 | 0-1 | 0 = Off ; 1 = On |
| Mode | 18 | 0-1 | 0 = Guitar ; 1 = Bass |
| Low | 19 | 0-40 | 0 = -20dB ; 20 = 0dB ; 40 = 20dB |
| Low Mid | 20 | 0-40 | 0 = -20dB ; 20 = 0dB ; 40 = 20dB |
| Mid | 21 | 0-40 | 0 = -20dB ; 20 = 0dB ; 40 = 20dB |
| High Mid | 22 | 0-40 | 0 = -20dB ; 20 = 0dB ; 40 = 20dB |
| High | 23 | 0-40 | 0 = -20dB ; 20 = 0dB ; 40 = 20dB |
| Level | | | |
| Preset Level | 24 | 0-95 | 0 = -95dB ; 95 = 0dB |
| Reverb | | | |
| On/Off | 25 | 0-1 | 0 = Off ; 1 = On |
| Room | 26 | 0-7 | 0 = Room #0 ; 1 = Room #1... |
| Dry/Wet | 27 | 0-127 | 0 = 0% ; 63 = 50% ; 127 = 100% |
| Arcade mode | | | |
| Instrument | 28 | 0-1 | 0 = Guitar ; 1 = Bass |
| Cab | 8 | 0-x | 0 = Cab #0 ; 1 = Cab #1... |
| Mic | 13 | 0-7 | 0 = Mic #1 ; 1 = Mic #1... |
| Room | 26 | 0-7 | 0 = Room #0 ; 1 = Room #1... |
| Power Amp | 29 | 0-30 | 0 = Off ; 1 = min ; 30 = max |
| Distance | 30 | 0-44 | 0 = min ; 44 = max |
| Tone | 31 | 0-44 | 0 = min ; 44 = max |
| Contour | 32 | 0-40 | 0 = min ; 40 = max |
| Preset Level | 33 | 0-95 | 0 = -95dB ; 95 = 0dB |
| General | | | |
| Preset mode | 34 | 0-1 | 0 = Simulation ; 1 = Arcade |
| Out Level | 35 | 0-95 | 0 = -95dB ; 95 = 0dB ; 107 = 12dB |
| Mute | 36 | 0-1 | 0 = No mute ; 1 = Mute |

6.3 Control change (CC) - For V4 firmware

The following table indicates the Control Change numbers for every parameter, as well as their range and behavior. This table is valid for firmware version 4.

| Parameter | CC# | Range | Behavior |
|---|-----|-------|---|
| Simulation & IR Loader modes | | | |
| Power Amp | | | |
| On/Off | 0 | 0-1 | 0 = Off ; 1 = On |
| Model | 1 | 0-7 | 0 = Model #0 ; 1 = Model #1... |
| Volume | 2 | 0-30 | 0 = 0dB ; 30 = 30dB |
| Presence | 3 | 0-127 | 0 = 0% ; 63 = 50% ; 127 = 100% |
| Depth | 4 | 0-127 | 0 = 0% ; 63 = 50% ; 127 = 100% |
| Type | 5 | 0-1 | 0 = Triode ; 1 = Pentode |
| Miking | | | |
| On/Off | 6 | 0-1 | 0 = Off ; 1 = On |
| Cab | 8 | 0-x | 0 = Cab #0 ; 1 = Cab #1... |
| File A | 9 | 0-x | 0 = File #0 ; 1 = File #1... |
| File B | 10 | 0-x | 0 = File #0 ; 1 = File #1... |
| Folder A | 11 | 0-3 | 0= User 0 ; 1= User1; 2 = User 2 ; 3 = User 3 |
| Folder B | 12 | 0-3 | 0= User 0 ; 1= User1; 2 = User 2 ; 3 = User 3 |
| Mic A | 13 | 0-7 | 0 = Mic #1 ; 1 = Mic #1... |
| Distance A | 14 | 0-127 | 0 = 0% ; 63 = 50% ; 127 = 100% |
| Center A | 15 | 0-127 | 0 = 0% ; 63 = 50% ; 127 = 100% |
| Position A | 16 | 0-1 | 0 = Back ; 1 = Front |
| Level A | 35 | 0-107 | 0 = -95dB ; 95 = 0dB ; 107 = 12dB |
| Phase A | 36 | 0-1 | 0 = Normal ; 1 = Invert |
| Mute A | 37 | 0-1 | 0 = Off (no mute) ; 1 = On (mute) |
| Mic B | 38 | 0-7 | 0 = Mic #1 ; 1 = Mic #1... |
| Distance B | 39 | 0-127 | 0 = 0% ; 63 = 50% ; 127 = 100% |
| Center B | 40 | 0-127 | 0 = 0% ; 63 = 50% ; 127 = 100% |
| Position B | 41 | 0-1 | 0 = Back ; 1 = Front |
| Level B | 42 | 0-107 | 0 = -95dB ; 95 = 0dB ; 107 = 12dB |
| Phase B | 43 | 0-1 | 0 = Normal ; 1 = Invert |
| Mute B | 44 | 0-1 | 0 = Off (no mute) ; 1 = On (mute) |
| EQ | | | |
| On/Off | 17 | 0-1 | 0 = Off ; 1 = On |
| Mode | 18 | 0-2 | 0 = Guitar ; 1 = Bass ; 2 = Custom |
| Gain: Low | 19 | 0-40 | 0 = -20dB ; 20 = 0dB ; 40 = 20dB |
| Gain: Low Mid | 20 | 0-40 | 0 = -20dB ; 20 = 0dB ; 40 = 20dB |
| Gain: Mid | 21 | 0-40 | 0 = -20dB ; 20 = 0dB ; 40 = 20dB |
| Gain: High Mid | 22 | 0-40 | 0 = -20dB ; 20 = 0dB ; 40 = 20dB |
| Gain: High | 23 | 0-40 | 0 = -20dB ; 20 = 0dB ; 40 = 20dB |
| Freq: Low Cut | 45 | 0-127 | Specific mapping to Hz |
| Freq: Low | 46 | 0-127 | Specific mapping to Hz |
| Freq: Low Mid | 47 | 0-127 | Specific mapping to Hz |

| Parameter | CC# | Range | Behavior |
|--------------------|-----|-------|---|
| Freq: Mid | 48 | 0-127 | Specific mapping to Hz |
| Freq: High Mid | 49 | 0-127 | Specific mapping to Hz |
| Freq: High | 50 | 0-127 | Specific mapping to Hz |
| Level | | | |
| Preset Level | 24 | 0-95 | 0 = -95dB ; 95 = 0dB |
| Reverb | | | |
| On/Off | 25 | 0-1 | 0 = Off ; 1 = On |
| Room | 26 | 0-7 | 0 = Room #0 ; 1 = Room #1... |
| Dry/Wet | 27 | 0-127 | 0 = 0% ; 63 = 50% ; 127 = 100% |
| Arcade mode | | | |
| Instrument | 28 | 0-1 | 0 = Guitar ; 1 = Bass |
| Cab | 8 | 0-x | 0 = Cab #0 ; 1 = Cab #1... |
| Mic | 13 | 0-7 | 0 = Mic #1 ; 1 = Mic #1... |
| Room | 26 | 0-7 | 0 = Room #0 ; 1 = Room #1... |
| Power Amp | 29 | 0-30 | 0 = Off ; 1 = min ; 30 = max |
| Distance | 30 | 0-44 | 0 = min ; 44 = max |
| Tone | 31 | 0-44 | 0 = min ; 44 = max |
| Contour | 32 | 0-40 | 0 = min ; 40 = max |
| Preset Level | 33 | 0-107 | 0 = -95dB ; 95 = 0dB ; 107 = 12dB |
| General | | | |
| Preset mode | 34 | 0-2 | 0 = Simulation ; 1 = Arcade ; 2 = IR Loader |
| Out Level | 51 | 0-107 | 0 = -95dB ; 95 = 0dB ; 107 = 12dB |
| Mute | 52 | 0-1 | 0 = Off (no mute) ; 1 = On (mute) |
| Bypass | 53 | 0-1 | 0 = Bypass ; 1 = On |
| Preset | 54 | 0-127 | 0 = Preset #1 ; 1 = Preset #2... |

7. Specifications

7.1 List Of Power Amplifiers

| Designation | Characteristics |
|-------------|--|
| SE 6L6 | Configuration Single Ended - Class A with 6L6 |
| SE EL34 | Configuration Single Ended - Class A with EL34 |
| SE EL84 | Configuration Single Ended - Class A with EL84 |
| SE KT88 | Configuration Single Ended - Class A with KT88 |
| PP 6L6 | Configuration Push-Pull - Class AB with 6L6 |
| PP EL34 | Configuration Push-Pull - Class AB with EL34 |
| PP EL84 | Configuration Push-Pull - Class AB with EL84 |
| PP KT88 | Configuration Push-Pull - Class AB with KT88 |

7.2 List of cabinets

| Designation | Inspired by |
|------------------------|--|
| GUITAR cabinets | |
| 2Notes CSG | Two Notes Custom 1×12" ElectroVoice® EVM12L |
| Angl VintC | Engl® 4×12" Celestion® V30 |
| Blonde 63 | Fender® Bassman '63 Blonde Tolex Piggy Back 2×12" |
| Brit 65C | Marshall® 1965A 4×10" Celestion® G10L-35 close back |
| Brit VintC | Marshall® Slash Signature 4×12" Celestion® V30 close back |
| Calif StdC | Mesa/Boogie® Rectifier® Standard 4×12" Celestion® V30 close back |
| Eddie | Peavey® 5150 2×12" Sheffield 1200 |
| Free Rock2 | VHT® Deliverance 2×12" Eminence® P50E |
| Green Tri | Hughes&Kettner® Triamp 4×12" Celestion® Greenback |
| Jazz 120 | Vintage Roland® JC120 2×12" |
| JubilGreen | Marshall® 2550 2×12" Celestion® Greenback |
| Kerozen | Diezel® 4×12" Celestion® V30 |
| Silver77 | Vintage Fender® Twin Reverb® 2×12" orange JBL® |
| SilverJen | Vintage Fender® Twin Reverb® 2×12" Jensen® C12K |
| The One | Brunetti® Neo1512 1×15" + 1×12" |
| Vibro Utah | Vintage 1961 Fender® Vibrolux® 1×12" original Utah speaker |
| Vibro V30 | Vintage 1961 Fender® Vibrolux® 1×12" Celestion® V30 |
| Voice 30 | Original Vox® AC30 JMI 2×12" Celestion® « Silver Bell » |
| Voice 65 | 1965 Vox® 2×12" |
| VoiceModrn | Vox® V212H, 2×12" Celestion® Alnico Blue |
| Watt FanC | Hiwatt® 2×12" Fane close back |
| XTCab | Bogner® 4×12" Celestion® V30 |
| BASS cabinets | |
| 2Notes CSB | Two Notes Custom 1×15" |
| Alu XL | Hartke® XL 4×12" |
| AZ Ben | SWR® Big Ben 1×18" |
| AZ Work | SWR® WorkingMan 4×10" |
| Calif Low | Mesa/Boogie® 2×10" |
| Fridge | Ampeg® 8×10" |
| Heaven Bot | David Eden® 1×15" |
| Heaven Top | David Eden® 4×10" |
| Marco | Markbass® 2×10" |
| Voice V125 | Vox® V125 2×12" |

7.3 List of Microphones

This is the list of microphones provided with the virtual cabinets found in the memory of your Torpedo Live. If you buy other cabinets from the [Two notes Store](#), you will find other microphones (more than a hundred models), depending on the selection made by the Capture Master who created the virtual cabinet.

| Designation | Inspired by |
|--------------|---------------------------------------|
| Dynamic 57 | Dynamic microphone Shure™ SM57 |
| Dynamic 421 | Dynamic microphone Sennheiser™ MD421 |
| Knightfall | Condenser microphone Blue™ Dragonfly |
| Condenser 87 | Condenser microphone Neumann™ U87 |
| Ribbon160 | Ribbon microphone Beyerdynamic™ M160N |
| Ribbon121 | Ribbon microphone Royer™ R121 |
| Bass 20 | Dynamic microphone Electrovoice™ RE20 |
| Bass 5 | Dynamic microphone Shure™ Beta52 |

7.4 Block diagram

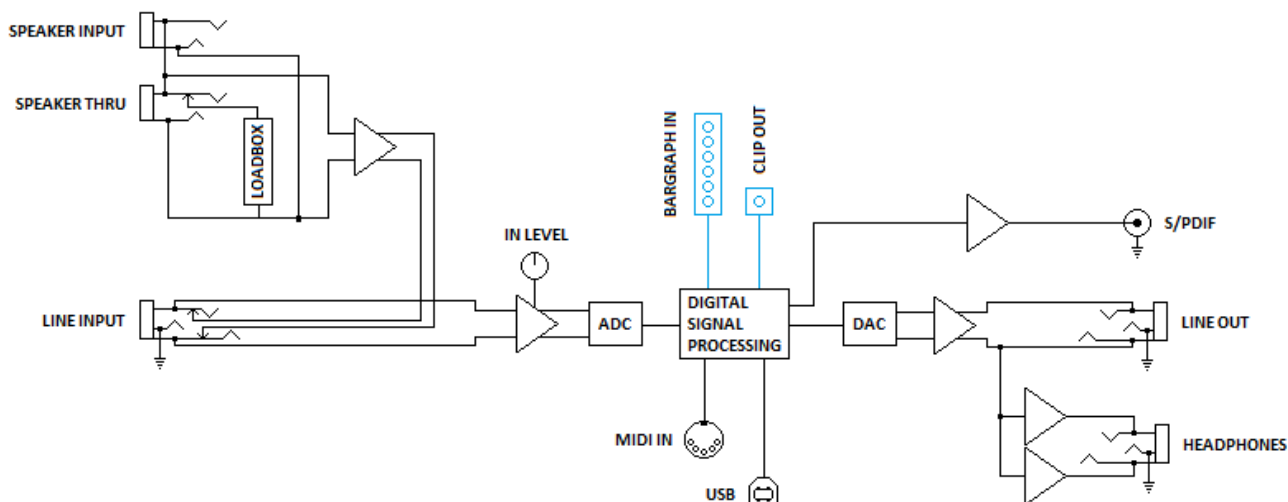

7.5 Technical Data

| Designation | Characteristics |
|----------------------|---|
| Speaker Input | Jack 6.35 mm (1/4") unbalanced (TS, Tip/Sleeve) Maximum input voltage: 280 V AC (51 dBu) Security load: 220 Ohms / 10 Watts |
| Line Input | Jack 6.35mm (1/4") balanced (TRS, Tip/Ring/Sleeve) Maximum input level: 36 dBu Input impedance: 10 KOhms |
| Loadbox | Reactive Load, nominal impedance: 8 Ohms Maximum admissible power: 100W (assuming proper ventilation) (see this article if your amplifier is more powerful) Cooled by temperature-controlled fan High Impedance mode if a cabinet is connected to the THRU output (loadbox is disconnected). |
| Speaker Thru | Jack 6.35mm (1/4") unbalanced (TS) |

| Designation | Characteristics |
|----------------------------------|---|
| Line Output | Jack 6.35mm (1/4") balanced (TRS) Impedance: 470 Ohms Maximum output level: <ul style="list-style-type: none"> • (no load, balanced): 16.5 dBu • (10k Ohms load, balanced): 16 dBu • (no load, unbalanced): 11 dBu • (10k Ohms load, unbalanced): 10.5 dBu |
| Headphones Output | MONO out, Jack 6.35mm (1/4") balanced (TRS) |
| S/PDIF | Sampling frequency: 48 or 96 kHz Master only, no external synchronization Possibility to send Dry and/or Wet signal |
| ADC | Gain controlled by analogue potentiometer, -inf to 0dB Minimal full-scale input level: -2.8 dBu (Line Input) Sampling frequency: 96 KHz Resolution: 24 bits Signal to noise ratio: 100 dB |
| DAC | Sampling frequency: 96 kHz Resolution: 24 bits Noise level: -105 db |
| Frequency response (-1db) | 5 Hz - 19 kHz |
| Latency | 1.7 ms (Line Input to Line Output) |
| Thermal security | Temperature-controlled fan At 100°C, a visual warning is displayed and -12 dB attenuation is applied on the signal At 110°C, the loadbox is disconnected, the amplifier sees a 220 Ohms security load, and signal is muted. |
| Power supply | IEC60320 C14 power connector Input voltage: 85-264 V AC, 47-63 Hz Power: approx. 10 W |
| Dimensions | Width: 430mm, 483mm including rack-mounting edges Depth: 163mm, 182mm including connectors and knobs Height: 44mm Weight: 2 kg |

7.6 Connectors wiring

TS 6.35mm (1/4") JACK

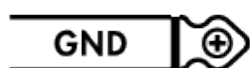

TRS 6.35mm (1/4") JACK



MALE XLR

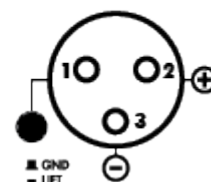

8. Technical support

Should you encounter a problem with your product or need help regarding any technical aspects, please note that Two notes Audio Engineering has developed on-line services to provide you with fast and efficient technical support, the [Two notes Help Desk](#).

Don't hesitate to browse the [Knowledgebase](#), which contains all sorts of useful informations, or [submit a ticket](#) if you have any question or need assistance with a Two notes product.

8.1 Two notes Website

On the [Two notes Audio Engineering](#) website, you will find:

- news about the company and the products (news on the homepage),
- comprehensive information about the Torpedo Live and its many applications (FAQ),
- firmware and software updates to download (products/Torpedo Live/downloads),
- access to the Two notes Store where you can buy new cabinets,
- the Torpedo BlendIR software (products/Torpedo Live/downloads),
- an official forum where you can share tips and advice with other Torpedo users (forum).

The Two notes Team often visits specialized forums to help out users.

8.2 E-mail

We do not offer technical support via e-mail. Please contact us via the Help Desk at the address above.

From:
<http://wiki.two-notes.com/> - **User's manuals**

Permanent link:
http://wiki.two-notes.com/doku.php?id=torpedo_live:torpedo_live_user_s_manualv2&rev=1561562018

Last update: **2019/06/26 17:13**

